

Order Form

SwingRiser Inner Post Replacement

Standard height (80 inch) inner round post

A separate order form is required for each unique operator ordered. If you have multiple identical operators, with NO variances, indicate total quantity here: _____

Date: _____ Post or Operator SN: _____

Purchase order #: _____ Contact phone: _____

Contact email: _____

INSTRUCTIONS: Check one box within each of the numbered sections below. The Order Form must be fully completed and signed before the order will be processed.

IMPORTANT: Gate speed, direction of swing, and degree of swing are fixed and cannot be changed in the field. Operator handing is determined by **STANDING ON THE SECURE SIDE OF THE GATE LOOKING OUT** toward the public side of the gate.

- SwingRiser posts have two main configurations, ROLI and RILO. These come in either 90 degree or 100 degree swing.
- ROLI stands for Right Out Left In. If this post is placed on the Right it will Swing Out and if placed on the Left will Swing In.
- RILO stands for Right In Left Out. If this post is placed on the Right it will Swing In and if placed on the Left will Swing Out.
- The Index Arm and access panels will always be located on the secure side

1) Degree of Swing:

- 90° swing (standard) 100° swing

2) Gate Handing for the SwingRiser (HRG 220):

- Left hand, swing out Right hand, swing out
 Left hand, swing in Right hand, swing in

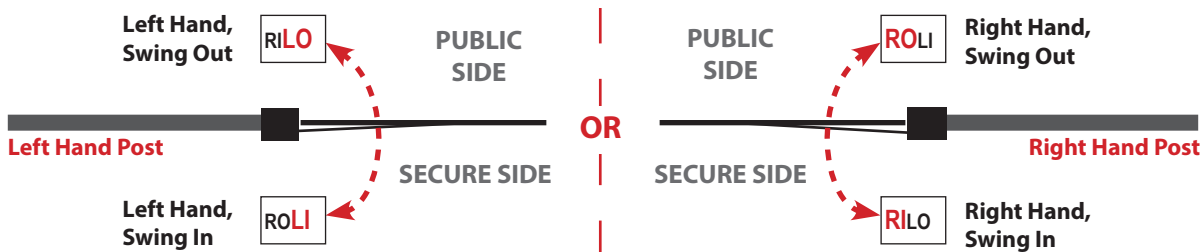

Part Numbers:

Inner Post Only

MX000941 RILO 90

MX000942 ROLI 90

MX000943 RILO 100

MX000944 ROLI 100

Inner Post w/Hydraulics

MX001361 RILO 90

MX001389 ROLI 90

MX002819 RILO 100

MX002820 ROLI 100

Hoses:

Hoses are ordered on a separate order form. In most installations, the hose order is placed after the operator is installed to ensure that hose lengths are accurate.

Double check that one box within each of the numbered sections above has been checked. The Order Form must be fully completed and signed before the order will be processed.

It is the responsibility of the customer to verify that the information on this order form is accurate. All custom orders are non-returnable.*

Ship To Company: DF Supply, Inc.

Address: 10050 Wellman Rd.

City, State, Zip: Streetsboro, OH 44241

SwingRiser™ Reference Information

Note: All Lateral Forces Must Be Supported By Backing Post / Pilaster.

Standard Operator Configuration / Dimensions

Right Hand Post Shown - Left Hand Post Is Mirror Image

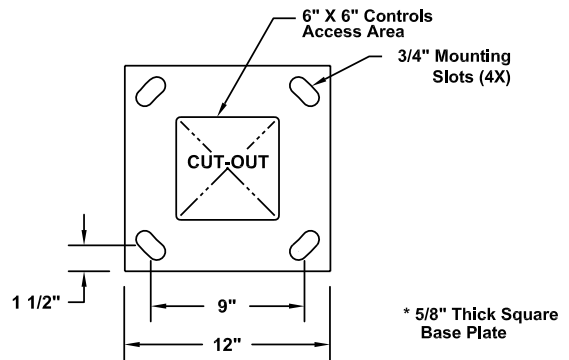
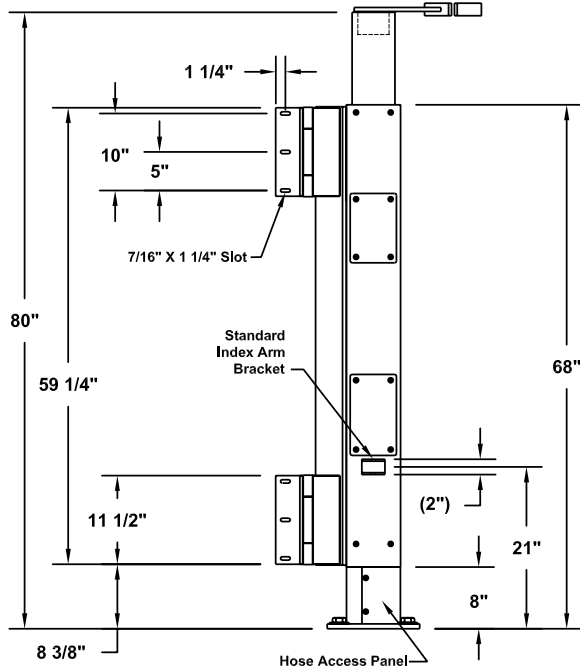

Baseplate / Footprint Dimensions

Top Cap Options

4" Pipe Bracket

Use Restricted To 1000 LB, 12' Long Gate Panels Max.

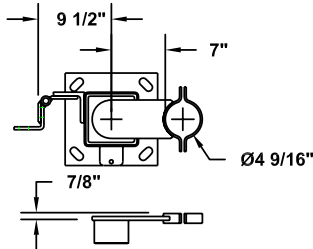

6" Pipe Bracket

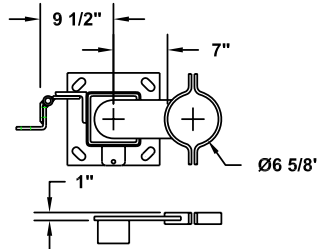

8" Pipe Bracket

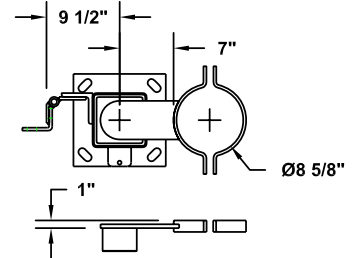

Pilaster Bracket

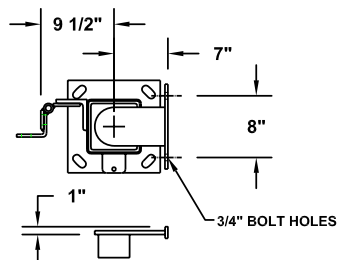

6" Sq Tube Bracket

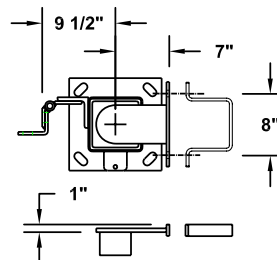

Customized SwingRiser™ Post

Note: All Lateral Forces Must Be Supported By Backing Post/Pilaster

Note: Top Caps Add Height

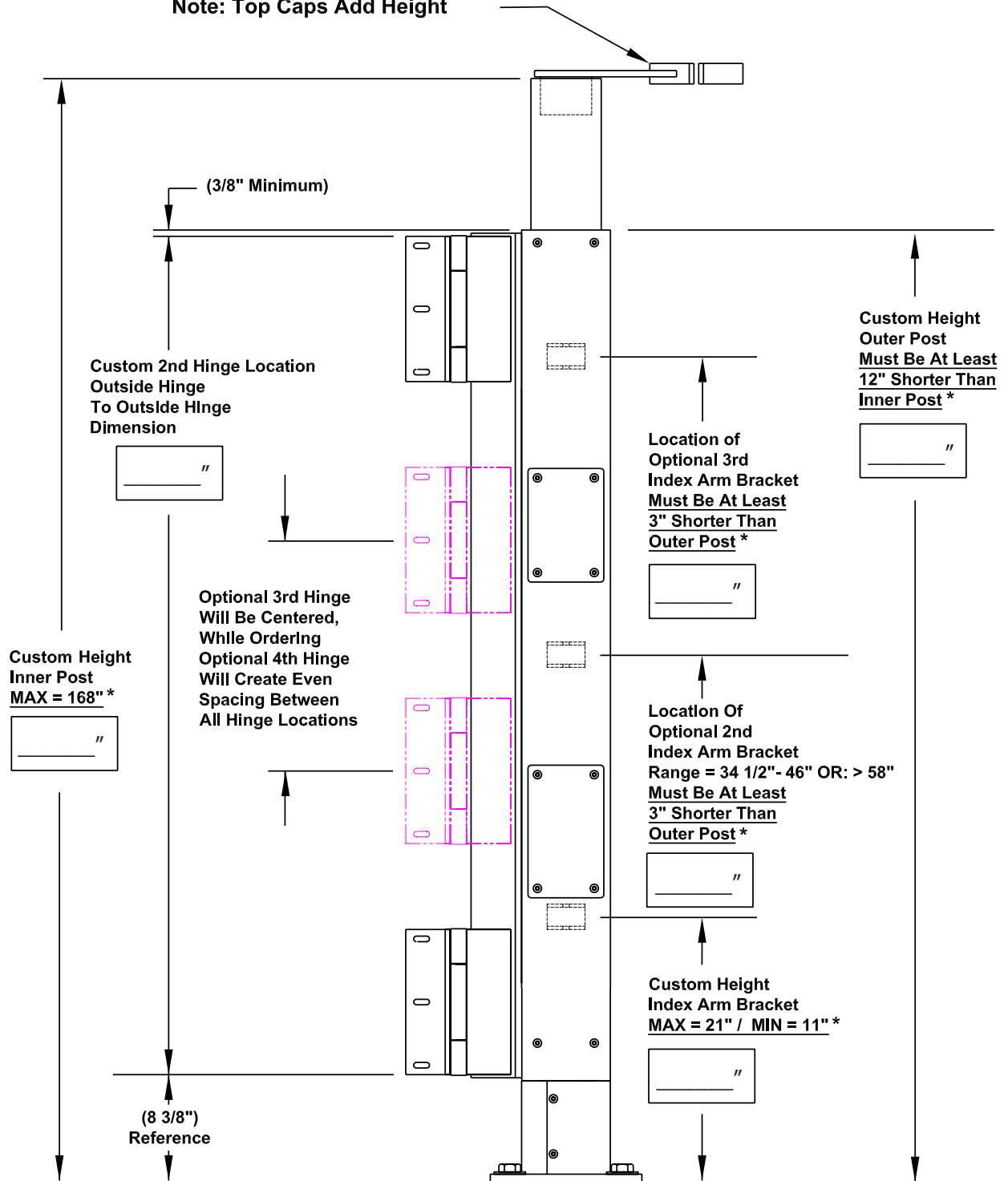

* Important Minimum Or Maximum Dimension